

Messumlenker Hub 4 mm
 Renvoi de mesure Course 4 mm

MU .. K ..

Ausführung K
 Execution K

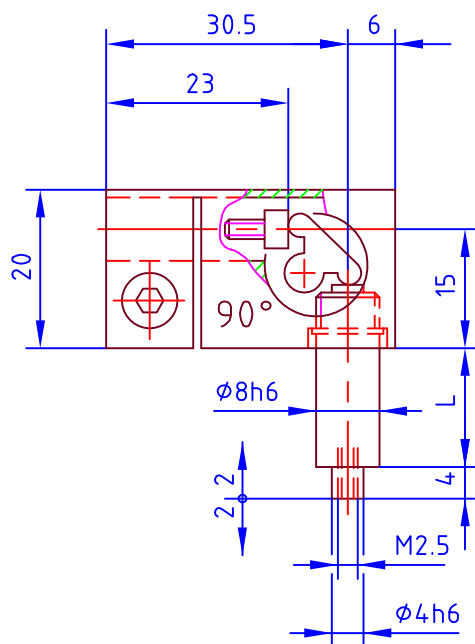
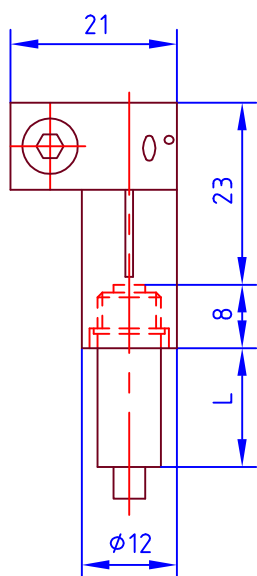

Type G

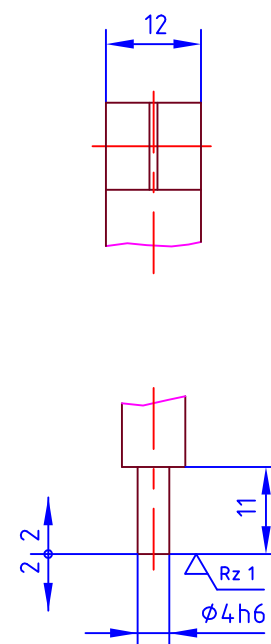

Type P

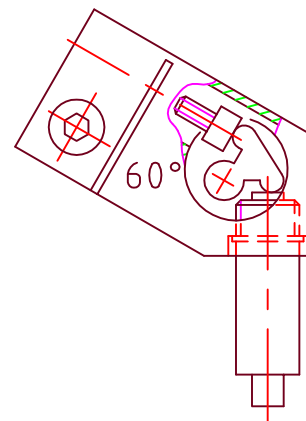
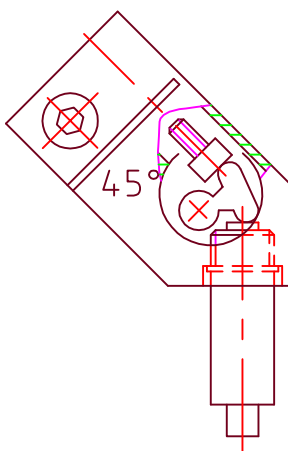
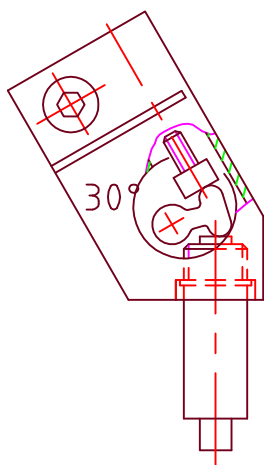

L	15	25	50	75	100	125	150	175	200
---	----	----	----	----	-----	-----	-----	-----	-----

Best. Nr.:
 No. de cde.:

MU 30 K 15 G

Messumlenker Renvoi

Type

Winkel Angle

Länge / Longueur L

Ausführung Execution

Messumlenker Hub 10 mm
 Renvoi de mesure Course 10 mm

MU .. XL ..

Ausführung XL
 Execution XL

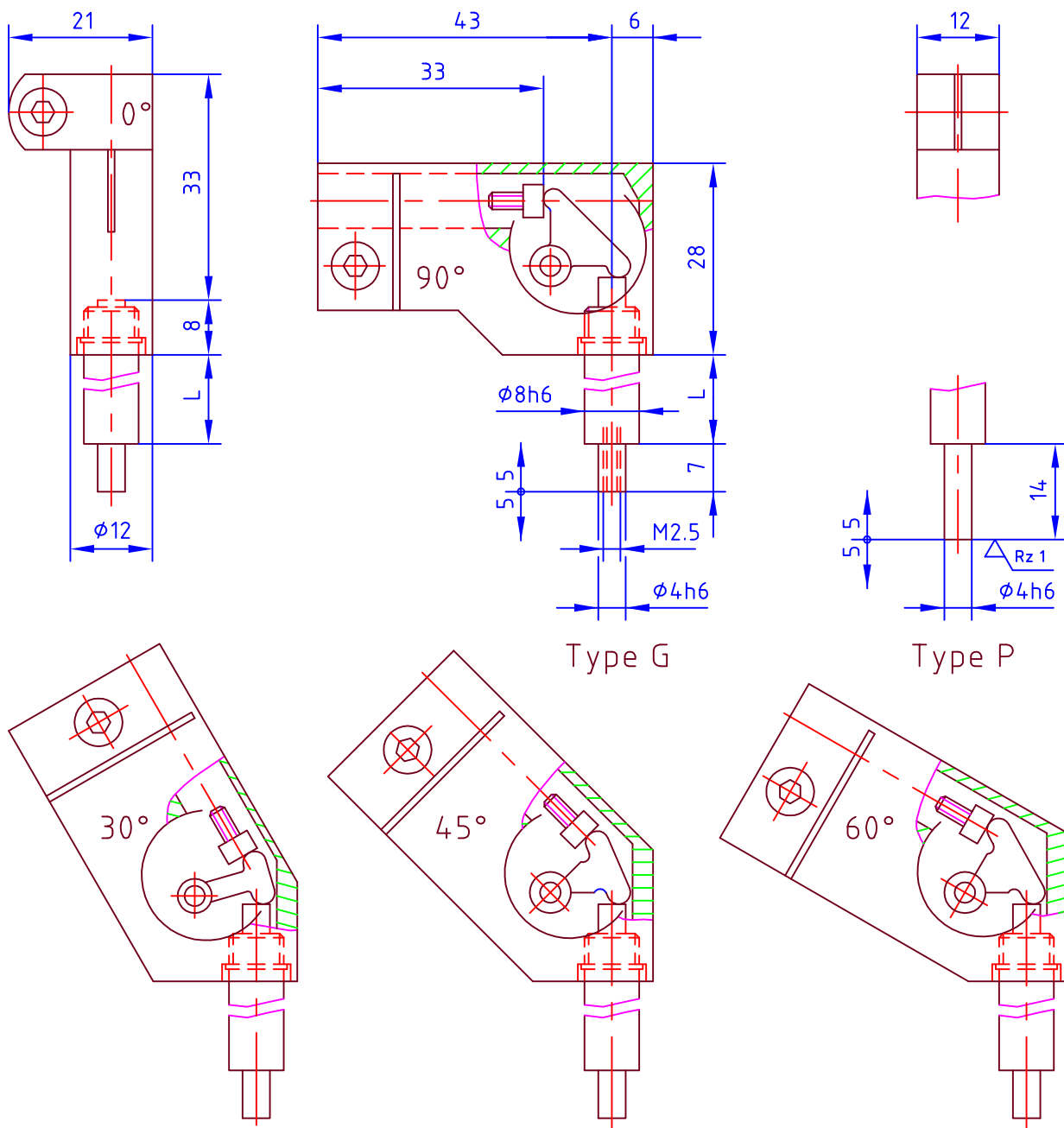

Type G

Type P

L	-	25	50	75	100	125	150	175	200
---	---	----	----	----	-----	-----	-----	-----	-----

Best. Nr.:

No. de cde.:

MU 30 XL 25 G

Messumlenker Renvoi

Type

Winkel Angle

Länge / Longueur L

Ausführung Execution